

Jaymart



Aluminium entrance matting systems



Rubber and vinyl floor coverings



Multi purpose mats and matting



Natural carpeting and domestic mats



Entrance/foyer matting

FOR FURTHER INFORMATION, FREE COPIES OF ANY OF OUR OTHER BROCHURES
OR FREE SAMPLES PLEASE PHONE:

01373 864926

www.jaymart.co.uk

email: matting@jaymart.co.uk

Jaymart Rubber & Plastics Ltd., Woodlands Trading Estate, Eden Vale Road, Westbury, Wiltshire BA13 3QS Fax: 01373 858454

CI/SfB

(43)

Tn

Jaymart

ANTI-FATIGUE AND DUCKBOARD MATTING

Jaymart

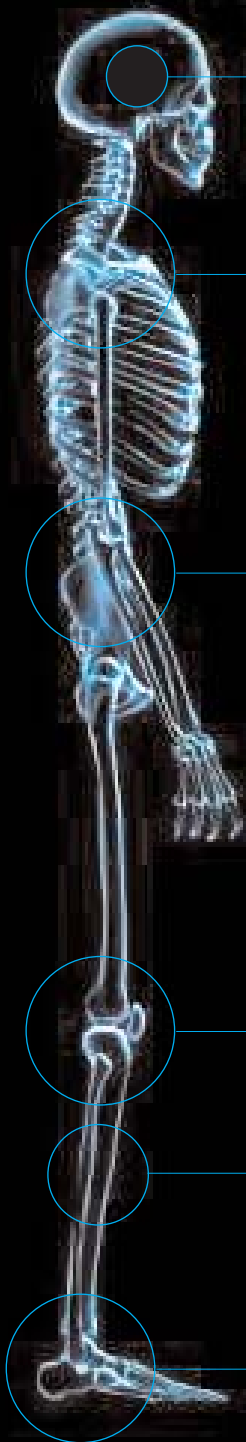

PREVENTS HEADACHES

EASES NECK AND
SHOULDER STIFFNESS

REDUCES LOWER BACK PAIN

MINIMISES STRAIN ON KNEES
AND OTHER JOINTS

STIMULATES CIRCULATION AND
PREVENTS VARICOSE VEINS

EASES STRESS ON ANKLES, AND
PROTECTS AGAINST TIRED FEET

Stand...

Jaymart's range of anti-fatigue matting is the best way of keeping both your employees and your profits in good condition.

There is plenty of evidence of the tiredness, pain and other physical problems that standing still for a long time can inflict on various parts of the body; so Jaymart's anti-fatigue matting has been developed to encourage foot movement in people who, for whatever reason, find themselves standing up for extended periods of time.

When people shift their feet they expand and contract their leg muscles, keeping the blood circulating in their legs and feet, and greatly reducing their chances of suffering muscular problems or varicose veins as a result. This foot movement also has the effect of altering people's posture enough that they avoid putting prolonged pressure on the same muscles and joints, thereby preventing muscle spasms, tension and pain.

With Jaymart's anti-fatigue matting your people will be kept fitter, healthier, motivated and more productive.

Unlike cold, hard floors, anti-fatigue matting creates a comfortable and healthy working environment that helps to protect against headaches, backache, stiff or swollen joints, muscular pain and simple fatigue; allowing people to concentrate for longer, and reducing their chances of having an accident.

...and deliver

The result of all this is that people are happier, their energy levels are higher, they work better for longer, and productivity is increased: it has, in fact, been shown that people who work standing up can reduce their levels of fatigue by up to 50% simply by standing on anti-fatigue matting.

Jaymart's anti-fatigue matting products also reduce the shock on joints when walking; some are even chemical and grease resistant, slip resistant even in wet conditions, resistant to static electricity, and what's more, with a great range of colours and styles they look good too.

So, with Jaymart's anti-fatigue matting, your people will be able to stand - & really deliver!

FOR MORE INFORMATION ON ANY ASPECT OF ANTI FATIGUE AND DUCKBOARD MATTING, PLEASE CALL JAYMART ON 01373 864926

Contents

ANTI-FATIGUE MATTING

Air-go	2
Diamond-Foot	2
Fatigue-Checker	3
Fatigue-Saver	3
Grandstand	7
Mat-Ease	4
Orthofloor	4
Picador	6
Safe-N-Sound	7
Safe-T-Zone	8
Soft Foot	5
Standby	5
Star Track	8
Topdeck	6
Treadlock	7
Workwell	6
Zed-Tred 90	4

DUCKBOARD MATTING

Crossgrip	13
Firmagrip	13
Flexigrid 2002	14
Floorline	12
Floorline	
Photo-Luminescent	12
Heronair	10
Heronrib 2000	10
Matwalk Safety	9
Nero-Standard	15
Nero-Stop	15
Pillomat	12
Safe-T-Grid	16
Safe-T-Guard	16
Surefloor	15
Versatile	14
Vynagrip	11
Vynagrip Plus	11

See also

Fatigue-Saver	3
Picador	6
Safe-T-Zone	8
Star Track	8
Topdeck	6
Treadlock	7

AIR-GO

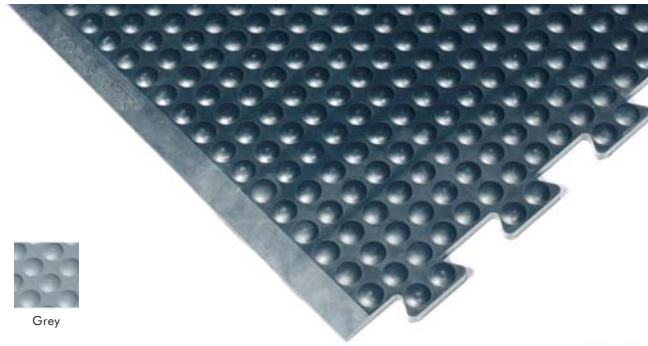

Air-Go is an ergonomic Scandinavian bubble design rubber anti-fatigue standing mat providing maximum relief for those whose jobs require prolonged periods standing i.e. Assembly lines, packing stations, cash desks, milling machines/lathes oil areas, mail rooms, shop counters, industrial work areas. Air-Go is manufactured from Nitrile rubber and is resistant to most oils and grease.

GAUGE 16mm

MAT SIZES:

SINGLE INDIVIDUAL MAT	Size 90cm x 60cm x 16mm thick with bevelled anti-trip edges on all 4 sides.
SYSTEM MATS	Interlocking system to enable users to create mats of any length.
(a) CENTRE SECTION	Size 70cm x 80cm x 16mm thick, with bevelled anti-trip edges on two side edges only and interlocking system on both ends.
(b) END SECTION	Size 30cm x 80cm x 16mm thick, with bevelled anti-trip edging on two sides and one end and interlocking system on the other end.

COLOURS: Grey or Black.

DIAMOND-FOOT



Super safe heavy duty anti-fatigue standing mats & matting. 4.5mm solid vinyl diamond plate deep embossed anti-slip surfacing on 9.5mm closed cell vinyl foam, giving an overall thickness of 14mm. Diamond-Foot not only protects against standing fatigue, reducing leg, back, foot and absenteeism problems, but also offers underfoot safety. Diamond-Foot is non-flammable, and resists oil, grease and chemicals.

GAUGE 14mm

MAT/ROLL SIZES: 90cm x 60cm 150cm x 90cm 300cm x 90cm 6m x 90cm

COLOURS: Black with Yellow borders or Grey.

ROLL SIZES: 6m x 120cm 22.8m x 90cm 22.8m x 120cm

COLOURS: Black with Yellow borders only.

FATIGUE - SAVER

FATIGUE-SAVER is an extra large heavy duty rubber open construction mat with bevelled anti-trip edging and built-in drainage. Specially designed to offer both anti-fatigue standing comfort and improved slip resistant safety underfoot.

FATIGUE-SAVER mats are available in a choice of two qualities, "Standard" (Black) or "Oil & Grease Resistant" (Terracotta). Both qualities are manufactured from cushioning resilient rubber, which enhances anti-fatigue properties and also assists in the unlikely event of trips or falls, besides reducing the risk of breakages to valuable products, tools etc.

GAUGE 12mm

MAT SIZES: 3.05m x 91cms
COLOURS: Standard Quality in Black
 Oil & Grease Resistant Quality in Terracotta

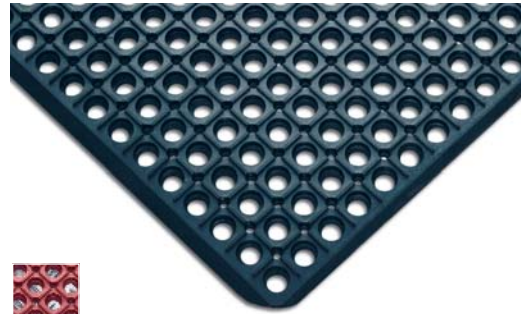

Terracotta



FATIGUE - CHECKER

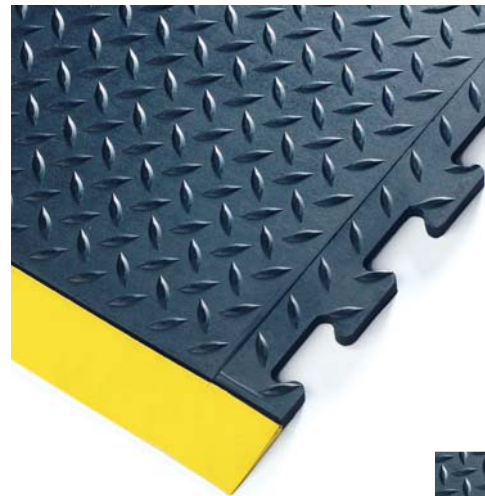

Plain Black

"FATIGUE-CHECKER" is an advanced stand alone/modular interlocking rubber anti-fatigue runner matting system with a superior slip-resistant diamond chequerplate design traction surfacing, sensational underfoot "airpocket" cushioning comfort and bevelled anti-trip safety edging, plus the optional extra of special yellow "safety alert" borders.

GAUGE 12mm

MAT SIZES:

SINGLE INDIVIDUAL MAT	Size 70cm x 78cm x 12mm thick with bevelled anti-trip edges on all 4 sides.
SYSTEM MATS	Interlocking system to enable users to create mats of any length.
(a) CENTRE SECTION	Size 70cm x 78cm x 12mm thick, with bevelled anti-trip edges on two side edges only and interlocking system on both ends.
(b) END SECTION	Size 70cm x 78cm x 12mm thick, with bevelled anti-trip edging on two sides and one end and interlocking system on the other end.

COLOURS: Available in plain Black or Black with Yellow "Safety Alert" bevelled edges.

MAT-EASE

Standing mat with superb scientific cushioning underside honeycombed air cells, specially designed to reduce the foot, back and body fatigue suffered by those who stand for a living. Mat-Ease can also reduce slips and fall accidents and reduce breakages and damages to valuable products, tools and parts.

GAUGE 12 mm

MAT SIZES:

- SINGLE INDIVIDUAL MAT Size 70cm x 78cm x 12mm thick with bevelled anti-trip edges on all 4 sides.
- SYSTEM MATS Interlocking system to enable users to create mats of any length.
- (a) CENTRE SECTION Size 70cm x 78cm x 12mm thick, with bevelled anti-trip edges on two side edges only and interlocking system on both ends.
- (b) END SECTION Size 70cm x 78cm x 12mm thick, with bevelled anti-trip edging on two sides and one end and interlocking system on the other end.

COLOURS: Black



ZED-TRED 90

Zed-Tred 90 is a ribbed PVC anti-fatigue matting 13mm thick. Zed-Tred has been designed and constructed utilising Plastic Extruders hardwearing Flexi-tred matting with patented Zed Land high density foam construction anti-fatigue matting thermally fused to its base - providing hardwearing, slip resistant ribbed surface that is cushioned to give a resilient 'bounce' underfoot which induces natural muscle flexing and thus reduces standing fatigue. The fused construction means Zed-Tred will never separate or delaminate.

GAUGE 13mm

ROLL SIZE: 10m x 100cm
COLOURS: Blue & Grey



Grey



Blue

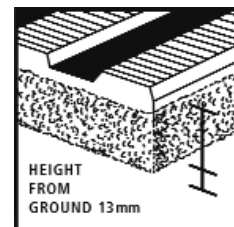

ORTHO FLOOR

ORTHO FLOOR is designed to provide an effective resilient rubber cushion flooring/ matting to substantially reduce great strains and pains associated with standing for long periods on hard surfaces. It has an attractive textured slip resistant surface for improved safety and can also be used very effectively in weightlifting areas of gymnasium and sports clubs. ORTHOFLOOR interlocking tiles can be laid "wall-to-wall" or in confined matting "islands" (bevelled edging available).

GAUGE 12 mm

MAT SIZES: 500mm x 500mm
COLOURS: Black or Red.

BEVELLED EDGE SECTIONS 500mm long x 75mm wide
 BEVELLED CORNER SECTIONS 250 x 250mm internal x 75mm wide
 CONNECTIONS 500mm long



Tile Connector



Bevelled Edging



Red

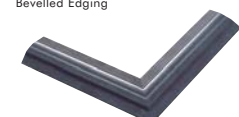

Bevelled Corner

SOFT FOOT



Black with Yellow Safety Borders

RIBBED



Plain Grey Plain Brown Plain Black

PEBBLE GRAINED



Plain Grey Plain Brown Plain Black



"SOFT FOOT" is a pebble grained or standard ribbed anti-slip closed-cell air cushioned vinyl foam anti-fatigue workstation standing matting (looselay). Soft Foot is an ergonomically designed, economical solution for improving workers comfort and productivity. Recommended uses include industrial work stations, checkout and service counters, exhibition stands etc. Mats and rolls have sealed anti-trip bevelled edging on all sides for increased safety. (N.B. Cut lengths can have the ends bevelled to create mats or rolls of any length up to 18.2m).

GAUGE 10mm

MAT SIZES: 90cm x 60cm 150cm x 90cm 3.6m x 90cm
9.1m x 60cm 9.1m x 90cm 9.1m x 120cm

COLOURS: Plain Black, Plain Grey, Plain Brown or Black with Yellow Safety Borders

ROLLS: 18.2m x 60cm 18.2m x 90cm 18.2m x 120cm 18.2m x 180cm

COLOURS: Plain Black, Plain Grey, Plain Brown or Black with Yellow Safety Borders

STANDBY

The "STANDBY" bubbled rubber ergonomic anti-fatigue standing mat provides superb scientific ergonomic under-foot cushioning comfort to all those who spend their working days on their feet.

All come with Yellow "SAFETY ALERT" anti-trip bevelled edges. They are extra hardwearing, insulate against cold, deaden noise, reduce breakages and are easy to keep clean and hygienic.

GAUGE 14mm

MAT SIZE: 120cm x 90cm
COLOUR: Black with yellow edges.

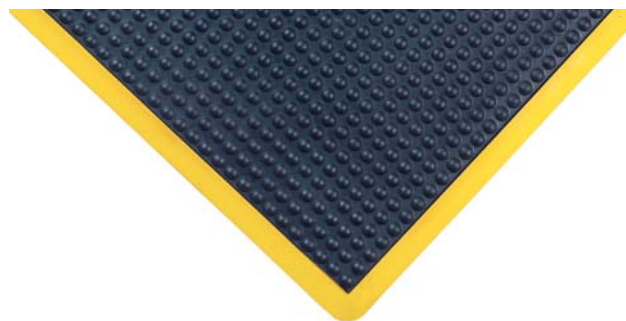

WORKWELL

Multi-directional slip-resistant Chequered "diamond plate" surfacing giving excellent traction and improved safety.

Moulded rubber "air pockets" on the underside of "WORKWELL" provide superb cushioning underfoot comfort to standing operatives. Solid anti-trip bevelled edging considerably reduces any danger of tripping. The modular interlocking matting system consists of main central sections and finishing end sections, enabling runners of virtually any length to be formed

GAUGE 12mm

MAIN CENTRAL "WORKWELL" MAT SECTION

SIZE: 71cm x 100cm, with bevelled anti-trip edges on two side edges only & interlocking system on both ends.

END "WORKWELL" MAT SECTION

SIZE: 71cm x 33cm, with bevelled anti-trip edges on two sides and one end and interlocking system on the other end.

COLOUR: Black.



TOPDECK

Octagonal design, open construction, all-purpose rubber anti-fatigue safety mats with moulded bevelled anti-trip edges 13mm thick. Topdeck mats are specially designed for commercial and industrial workstations for standing operatives. The open construction permits easy drain-through and dirt, catchment, etc.

GAUGE 13mm

MAT SIZE: 152cm x 91cm.

COLOURS: Oil and Grease proof nitrile quality Terracotta or standard quality (not oil or grease proof) Black.

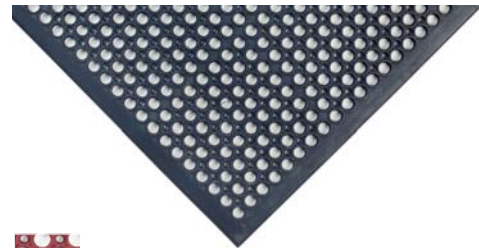

Terracotta

PICADOR



Best selling extra heavy duty top quality indoor/outdoor rubber link mat. Recommended for wet areas. Spillages are kept below the main walking or standing surface of the matting. Slip resistant.

GAUGE 23mm

MAT SIZE: 150cm x 100cm

COLOUR: Black or Black Oil Resistant

MAT SIZE: 100cm x 75cm 100cm x 50cm 75cm x 50cm 60cm x 40cm

COLOUR: Black only

PICADOR CONNECTOR CLIPS

Clips for joining PICADOR mats side to side or end to end, available in Standard quality or Oil Resistant Black.

PICADOR AD-MAT

Nylon Brush Infills considerably enhance the cleaning effectiveness of "PICADOR" mats, and also enable LETTERING to be incorporated, as well as colour (Available in Black, Blue, Green, Grey, Red and Yellow).

GRANDSTAND

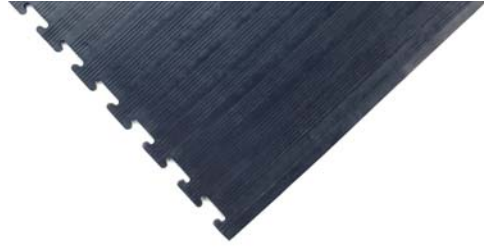
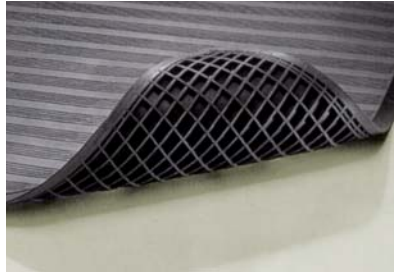

Grandstand is a classic anti-fatigue matting with a ribbed easy to clean surface and a honeycomb air cellular underside. Suitable for use behind shop counters, by industrial machines etc. Available in both stand alone and interlocking formats with bevelled edging where appropriate.

GAUGE 12mm

	FREESTANDING MAT	CENTRE SECTION	END SECTION
SIZE:	A M30 - 79cm x 71cm	B SIZE: M31 - 79cm x 71cm	C SIZE: M32 - 79cm X 71cm
COLOUR:	Black only		

SAFE - N - SOUND

Combined anti-fatigue/duckboard "SAFE-N-SOUND" is an extra long rubber open construction roll form duckboarding, specially designed to provide anti-slip safety and anti-fatigue underfoot cushioning. "SAFE-N-SOUND" has built-in drainage and also provides excellent slip-resistant in wet, oily or greasy floor areas.

GAUGE 12mm

ROLL SIZE: 10.6m x 91cm
COLOURS: Black or Oil and Grease resistant Terracotta.



Terracotta

TREADLOCK

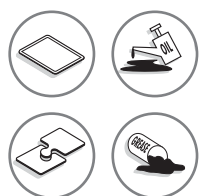
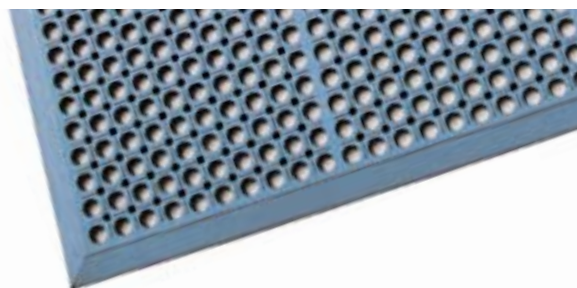

Terracotta

Treadlock is a superior quality interlocking rubber duckboard safety matting with bevelled edging. Large cylindrical holes and raised underside facilitate the drainage of spillages and the trapment of swarf, dirt etc below the main walking surface of the matting. Treadlock mats keep feet away from hard, wet or damp floors and the superb resilience of the rubber reduces the risk of back complaints, while cushioning falls, reducing breakages of valuable components. Treadlock mats and matting are supplied in a choice of "standard" rubber (Black) or special "oil and greaseproof" nitrile rubber (Terracotta) qualities.

GAUGE 21mm

	SINGLE MAT WITH STRAIGHT EDGES	SINGLE MAT	INTERLOCKING CENTRE MAT	INTERLOCKING END MAT
SIZE:	150cm x 90cm	A 155cm x 91cm	B 155cm x 91cm	C 155cm x 91cm
COLOUR:	Standard rubber- Black Oil & Greaseproof Nitrile rubber qualities - Terracotta			

- A** With bevelled anti-trip edges on all four sides.
- B** With bevelled anti-trip edges on two side edges and interlocking system on both ends.
- C** With bevelled anti-trip edges on two sides and one end and interlocking system on the other end.

STAR TRACK

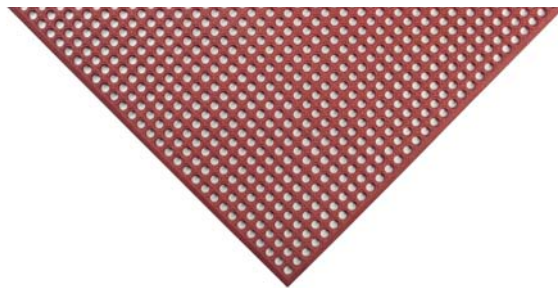
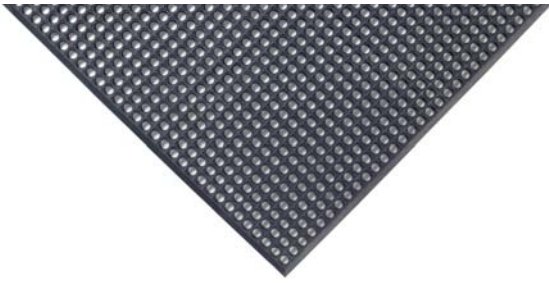

Star Track is a heavy duty open construction multi-purpose rubber link mat with an attractive built-in star 'scraper' ribbing. Star Track mats are slip resistant and easy to clean and are manufactured from naturally cushioning resilient rubber making Star Track an ideal anti-fatigue standing matting - providing relief for aching legs and feet and reducing breakages and damages to falling objects, tools, valuable parts etc. Star Track is also very effective in areas where water or liquid spillage are hazards its open construction allowing drainage below the walking area and reducing the slip hazard, making it ideal for use in bottling plants, breweries, behind bars, cellars, laundries etc. Bevelled anti-trip and anti-curl safety edges to all 4 sides make it safe for loose applications.

Available in Standard Black and Oil & Grease Proof Terracotta.

GAUGE 12mm

MAT SIZES: 1524mm x 914mm x 12mm
COLOUR: Black & Terracotta

SAFE-T-ZONE



Red open construction

Safe-T-Zone is an interlocking extra heavy duty rubber anti-fatigue safety duckboard matting, available in both grease proof (Brick Red) and grease resistant properties (Black). With its open construction, it gives an anti-fatigue quality to ease the strain on long-standing jobs. Ideal for commercial kitchen, fast food shops, food service areas, public houses, bars, machine shops, laboratories, meat & poultry plants, assembly areas, garage workshops, factories etc. Safe-T-Zone rubber duckboard mattings are supplied in interlocking modules, so large floor areas can be quickly and easily covered.

GAUGE 16mm

OPEN CONSTRUCTION

MAT SIZES: 915mm x 915mm 1520mm x 915mm
COLOUR: Brick Red (grease proof quality) and Black (grease resistant quality)

CLOSED CONSTRUCTION

MAT SIZES: 915mm x 915mm only
COLOUR: Standard quality Black only.

BEVELLED EDGE INTERLOCKING SECTION

MAT SIZES: 995mm x 75mm
COLOUR: Black, Yellow and Brick Red.



Black closed construction



Black open construction with yellow beveled edging

MATWALK SAFETY



Blue, Grey



Black

Matwalk Safety is an indoor/outdoor cross-ribbed high impact looselay vinyl slatted "wet area" duckboard matting with superior slip resistant surfacing.

GAUGE 11mm

WIDTH: 60cm, 80cm, 100cm, 120cm, 200cm
ROLL LENGTH: 10 metres long
COLOUR: Yellow, Blue, Red, Green, Grey, Black, Brown, Cream.

For use in: Shower Rooms, Changing Rooms, Swimming Pool Surrounds, Saunas, Washrooms
 NB Bare-foot areas only.

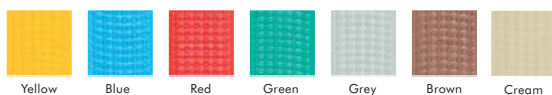

Yellow Blue Red Green Grey Brown Cream

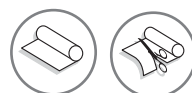

Two colour combinations available by special order, against quotation.

HERONRIB 2000



Charcoal Gray

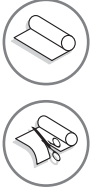
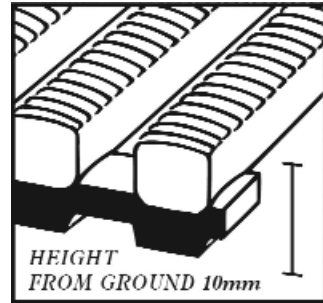

HERONRIB 2000 is the ideal self-draining safety matting for all sports and leisure surroundings. It is made from strong yet flexible PVC sections with channelled underbars for increased multi-directional drainage of large amounts of water. Heronrib 2000 contains Sanitized anti-bacterial and anti-fungal additives and with its embossed, slip-resistant surface it is warm, hygienic and comfortable to stand on even with bare feet.

Heronrib 2000 is easily cut to shape and size and is effective both indoors or outdoors. (Please note external UV resistance cannot be guaranteed in red colour.)

Applications include: Shower rooms, changing rooms, swimming pool surrounds, saunas, washrooms etc. N.B. bare-foot areas only.

GAUGE 10mm

WIDTH: 50cm, 100cm or 122cm
ROLL LENGTH: 10 metres long
COLOUR: Oxford Blue, Charcoal Grey, Forest Green, Mulberry Red & Ocean Blue.

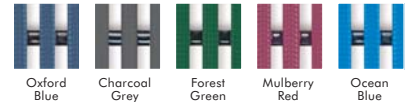

For use in: Shower Rooms, Changing Rooms, Swimming Pool Surrounds, Saunas, Washrooms

NB Bare-foot areas only.

HERONAIR



Black

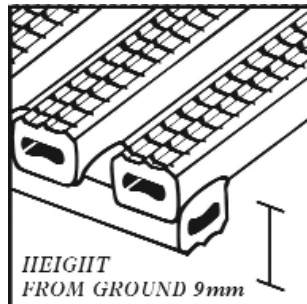

Heronair is made from extremely hardwearing flexible PVC – with tubular top surface and underbars designed to create maximum ‘cushion’ comfort underfoot. The matting is highly slip-resistant, insulating and economical. Impervious to wet, mildew, most acids and oils. Liquid spills drain away. Heronair Contours to uneven floor surfaces, with no fixing required.

GAUGE 9mm

WIDTH: 50cm, 75cm or 100cm
ROLL LENGTH: 10 metres long
COLOUR: Black

VYNAGRIP

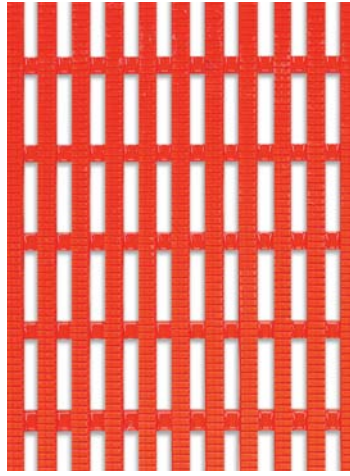

Red

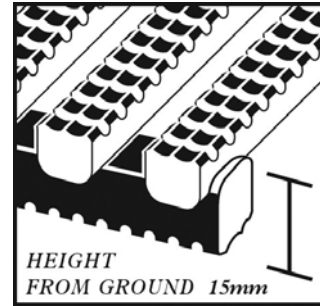

Black

Blue



Similar to Heronrib, Vynagrip shares all the same properties but is even tougher. A rugged “go anywhere” duckboard matting, Vynagrip has a whole host of optional extras to enable the user to customise the matting to his own particular requirements. Accessories include floor hooks, bevelled edge kits and connector clips.

GAUGE 15mm

WIDTH: 60cm, 91cm or 122cm
ROLL LENGTH: 10 metres long
COLOUR: Black, Red & Blue

VYNAGRIP PLUS

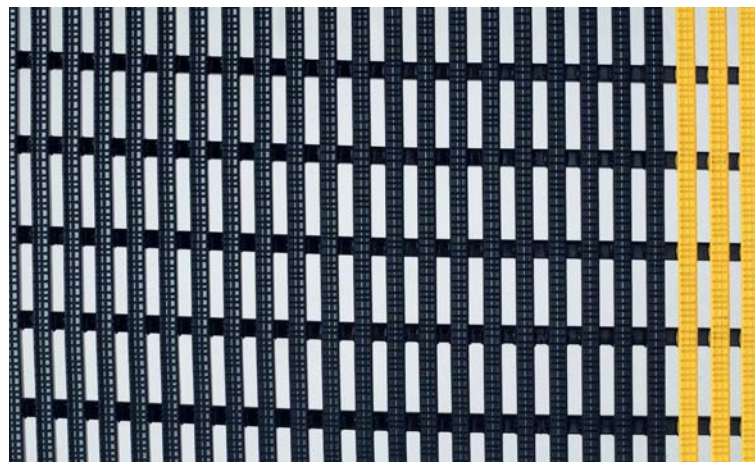

Black & Yellow



This duckboard matting simulates all the qualities of Vynagrip but now comes with Health and Safety conscious yellow safety edges.

GAUGE 15mm

WIDTH: 60cm, 91cm or 122cm
ROLL LENGTH: 10 metres long
COLOUR: Black/Yellow



Red & Yellow

FLOORLINE

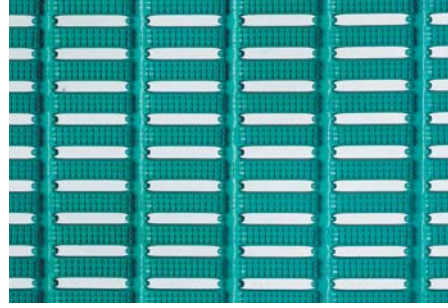

Canvas Green

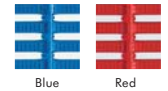
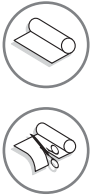
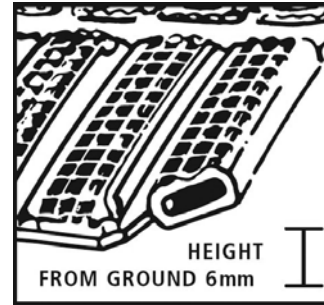

FLOORLINE light duty matting is decorative, soft and hardwearing. Suitable for light industrial or commercial areas where slip resistance is required. Its open grid vinyl construction dissipates spillages and the matting is impervious to most liquids, acids and oils. Floorline's cushioned comfort and insulating properties not only provide respite from hard and cold floors but also reduces the risk of breakages of dropped items. Its open-grid light tubular construction makes the matting light and easy to install and relocate as necessary.

GAUGE 6mm

WIDTH: 60cm or 91cm
ROLL LENGTH: 10 metres long
COLOUR: Blue, Green, Red, Powder Blue & Canvas Green

FLOORLINE PHOTO-LUMINESCENT

FLOORLINE PHOTO-LUMINESCENT is a specially manufactured version of Floorline, incorporating an photo-luminescent light emitting band to provide escape route and safety marking when lighting fails. Tested to DIN67510 Part 4 after glow properties (15.5/1.65 – 239/w-k).

GAUGE 6mm

WIDTH: 10m x 60cm or 91cm
ROLL LENGTH: 10 metres long
COLOUR: Black with photo-luminescent strip

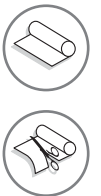
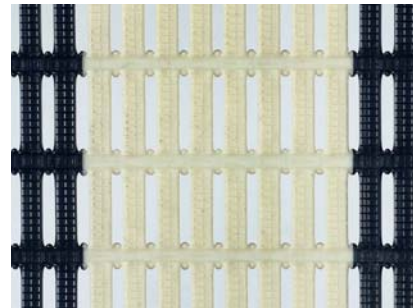

PILLOMAT

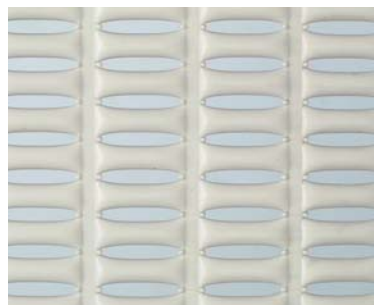

White

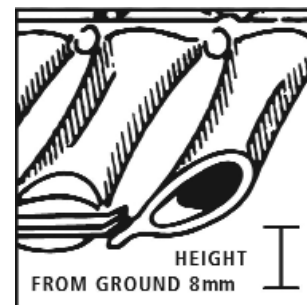

Pillomat is an all purpose cushion matting for use on working surfaces such as work benches and shelves for compartment lining. The hollow section of the matting is air filled to provide a lightweight and hygienic cushioning surface. It acts as a clean and noise-free covering which will resist contamination, absorb impact and reduce breakages. Pillomat's open grid design facilitates drainage, resists oils, grease and chemicals & is easy to clean.

GAUGE 8mm

WIDTH: 60cm or 91cm
ROLL LENGTH: 10 metres long
COLOUR: Green, Mahogany, Beige & White

CROSSGRIP

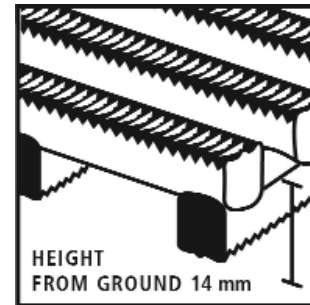

CROSSGRIP roof walkway matting provides all weather safe access on flat roofs for maintenance of roof services. Crossgrip does not react with vinyl roofing membranes whilst providing continual protection to the roof's covering from pedestrian traffic. It is UV resistant, impervious to all weathers and, due to its open grid design, provides permanent slip resistance even in areas where water may pool. Crossgrip is lightweight and flexible enabling it to contour to bumps and ensuring quick and easy installation. The matting is maintenance free and its lifespan will equal or exceed that of modern flat roofing materials.

GAUGE 14 mm

WIDTH: 60cm, 91cm or 122cm
ROLL LENGTH: 10 metres long
COLOUR: Battleship Grey

FIRMGRIIP

Firmagrip is the ideal matting to provide a slip-resistant surface in areas where there is a high volume of pedestrian traffic or wheeled traffic activity. The matting is designed with a close mesh format which ensures stability, permits spillages to drain through but avoids fall through of small components. Classified R11, V10 Firmagrip is highly slip-resistant and suitable for wheeled traffic. Also resistant to oils and chemicals.

GAUGE 14 mm

WIDTH: 60cm, 91cm or 122cm
ROLL LENGTH: 10 metres long
COLOUR: Red, Green & Black

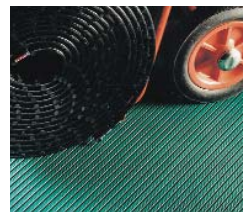

Green

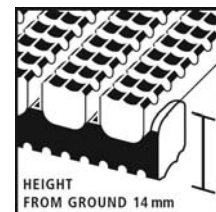

Red

Black

FLEXIGRID 2002

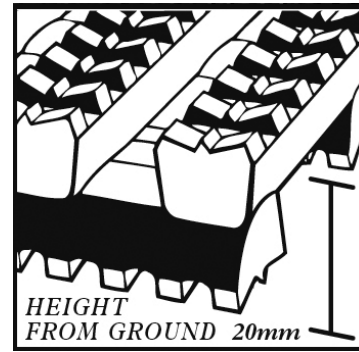

Flexigrid 2002 is a new hardwearing matting for heavy industrial areas ideal for use where a production process can generate dirt, grime and spillages of liquids and metal chips. An extra aggressive slip-resistant tread pattern (DIN 51130 R11) ensures safety underfoot whilst its flexible grid construction reduces fatigue and makes it comfortable to stand on. Flexigrid 2002 is able to cope with the heaviest of spillages or harshest of applications, and is resistant to acids, oils and most chemicals.

Made from recycled factory waste & is also recyclable at end of Flexigrid's use.

GAUGE 20mm

WIDTH: 60cm or 91cm
ROLL LENGTH: 10m or 5 metres long
COLOUR: Black

FLEXIGRID 2002 MODULES

Heavy duty industrial matting.

GAUGE 20mm

WIDTH: 60cm or 91cm
LENGTH: 1.8m metres long
COLOUR: Black

VERSATILE

Versatile is a high-tech all purpose open construction indoor/outdoor raised flooring whose unique properties render it suitable for use in sports areas, wet areas, and in commercial, industrial and domestic applications. Manufactured in a high-density polyethylene, Versatile's interlocking floor system allows speedy laying and uplift if required.

GAUGE 20mm Senior **GAUGE** 14mm Junior

TILE SIZE: 333mm x 333mm
COLOUR: Green, White, Black, Red, Blue

LINE MARKING/BORDER SECTIONS

SIZE: 333mm x 50mm x 20mm thick
COLOUR: Green, White, Red, Blue, Black

BEVELLED EDGE SECTIONS

SIZE: 333mm x 75mm x 20mm
COLOUR: Green only

BEVELLED EDGE CORNER SECTIONS

SIZE: 75mm x 75mm x 20mm
COLOUR: Green only

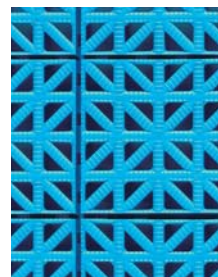

Blue

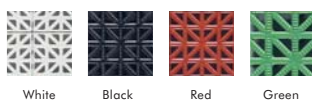
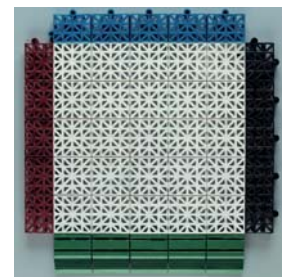

NERO - STOP

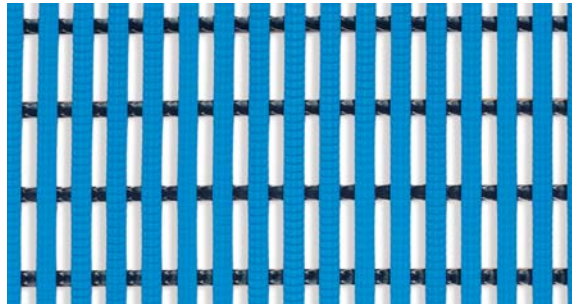

Dark Blue



Specialist wet area looselay decorative vinyl duckboard mattings with open construction drainage facility. Nero Stop has an embossed lightly ribbed surfacing for extra slip-resistant safety. For use in: Washrooms, Cellars, Cold Storage Rooms, Balconies, Laundries, Ships etc as well as in oily or wet industrial areas i.e. by machines, assembly and packing lines, in gangways in kitchens, bars, etc.

GAUGE 11 mm

WIDTH: 60cm or 90cm

ROLL LENGTH: 10 metres long

COLOUR: Dark Blue, Light Blue, Red, Green, Brown, Sand, Yellow, Black, Ivory & Grey

NERO - STANDARD

Nero-Standard duckboard matting has an extra attractive smooth surface for superior ease of cleaning, but is not quite so slip resistant as Nero Stop. For use in drier conditioned areas e.g. walkways and corridors commercial and public buildings, universities, schools, nurseries, old people's homes, exhibition stand flooring, display areas, private houses etc.

GAUGE 11 mm

WIDTH: 60cm or 90cm

ROLL LENGTH: 10 metres long

COLOUR: Dark Blue, Light Blue, Red, Green, Brown, Sand, Yellow, Black, Ivory & Grey



Black

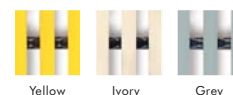
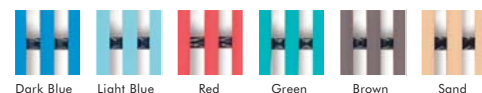

SUREFLOOR

Surefloor interlocking vinyl safety flooring tiles offer excellent multi-directional slip resistance in both wet and dry conditions, exceptional value for money, attractive appearance, simple maintenance and good resistance to oil, grease and most acids and detergents. Surefloor has an ingeniously designed open construction ribbed surfacing and texture, giving advanced underfoot safety in wet areas and other areas where slip and fall accidents can occur.

GAUGE 9 mm

TILE SIZE: 300mm x 300mm

COLOUR: Blue, Red, Green, Yellow & Black

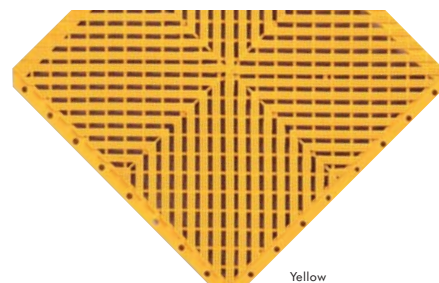

Yellow

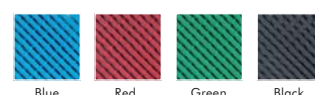

SAFE-T-GRID



Safe-T-Grid is an oil and grease resistant extra hard wearing anti-slip safety matting for all industrial and commercial applications where person's safety and working conditions are of paramount importance. Safe-T-Grid's construction and subtle roughened surface design provides excellent underfoot traction, whilst its open drainable design and extra 14.5mm height allows spillages, swarf and dirt to fall below the walking surface. Safe-T-Grid's ingenious convex design surfacing offers even speedier drainaway and drying. Furthermore Safe-T-Grid is flame resistant, easy to clean, lightweight, easy to roll-up and move, sound deadening, anti-static, thermally insulating, hygienic, easy to cut size or shape and offers exceptional value for money.

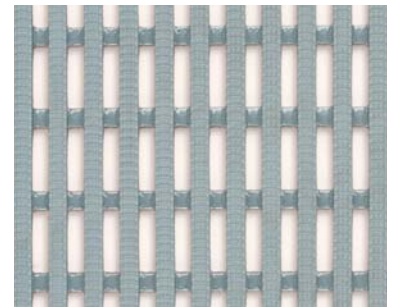

Grey



Dark Blue Black Red

GAUGE 14.5mm

WIDTH: 60cm, 90cm, 120cm or 180cm
ROLL LENGTH: 10 metres long
COLOUR: Dark Blue, Grey, Black, Red

SAFE-T-GUARD

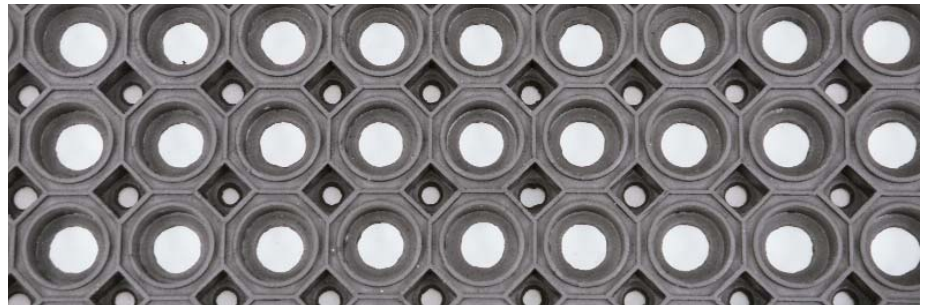

Extra heavy duty multi-purpose anti-slip octagonal open construction rubber safety mats for wet areas. Brilliant entrance mats, particularly in external or semi-exposed floor areas subject to rain, sea, snow, mud, sand etc. The attractive octagonal surface design acts as superbly effective scrapers while facilitating drainage, its strong sturdy grip assures slip resistance. Safe-t-Guard is also an excellent anti-fatigue standing matting/ duckboard and is ideal for use in factories, breweries, dairies, public houses, bottling plants, etc. Other uses include roofs, balconies, verandas, forecourts, washrooms, laundries, etc.



GAUGE 23mm

MAT SIZES: 50cm x 75cm 50cm x 100cm 75cm x 100cm 100cm x 150cm
COLOUR: Black.
CONNECTOR CLIPS: Clips for joining Safe-T-Guard mats side to side or end to end are available.

All quotations and contracts are subject to the following conditions unless otherwise stated subsequently by us in writing, and no qualification of these conditions in the customer order or acceptance shall be deemed to form part of this contract.

1. **Delivery:** Any items as to rate or time of DELIVERY are not to be deemed to be the essence of the contract and no guarantee can be given or implied thereto. We, however, will make every reasonable effort to ensure delivery in accordance with requirements so far as circumstances permit.
2. All orders are subject to our final acceptance at Westbury and thus the contract of sale is explicitly agreed to have been made at Westbury, Wiltshire. English Law shall apply and any dispute shall be settled in the English Courts.
3. ALL PRICES are quoted without engagement and, unless otherwise expressly stated by us in writing, subject to alteration without notice.
4. **DESPATCH OF ORDERS:** All goods are sent by the most convenient method available to us at the time of despatch unless otherwise specified. ANY GOODS FOR DELIVERY TO ADDRESSES OTHER THAN THOSE OF THE PURCHASER are only sent at the PURCHASER'S RISK.
5. **CARRIAGE:** Please see our current pricelist for carriage terms
6. **DELIVERY TO SITE:** THE PURCHASER WILL BE RESPONSIBLE FOR OFF-LOADING the goods and in accordance with normal transport practices such goods will be delivered to the goods inwards department or reception on the ground floor.
7. **SELECTION OF GOODS:** Is a matter solely for the purchaser, who should ascertain in advance of ordering, the suitability and colour, etc. of goods for the purpose required. Technical details and samples are available on request.
8. **TECHNICAL DESCRIPTION AND DATA.** Such descriptions whilst given as a guide in good faith are subject to alteration by the seller without notice. In particular all dimensions are approximate only.
9. **LIABILITY:** We will not be liable for any indirect or consequential loss whatsoever arising from, or in conjunction with, the supply of defective goods, delay in delivery, non-delivery, loss or damage to goods in transit or to the property of the purchaser, or any third person howsoever caused. If goods have been exported, customers are welcome to return the goods to our premises in Westbury where a decision can be made regarding any action to be taken.
10. **CLAIMS:** No claim for ANY DEFECT in goods supplied will be accepted unless made in WRITING within 3 days from the date of delivery. Goods returned to us within 10 days from receipt in exactly the same condition in which they were received, will be credited only if we also judge them to be defective, but will not form the subject of any claim for labour cost or other loss of any kind. No claim for loss or damage in transit will be accepted unless signed for as such and confirmed in writing and verbally within 10 days from the date of despatch. A clear signature to the carriers for goods concerned will indicate to the carriers and to us that they were received in perfect condition.
11. **DEFECTIVE GOODS:** Under no circumstances whatsoever will we accept return of goods for credit when they have already been installed, used or laid. Defects should be observed on receipt, i.e. prior to installation, use or laying, and be notified to us immediately, both verbally and in writing, so that we can decide what action may be taken. In the case of goods to be exported, inspection should be made prior to shipment.
12. **COLOURED GOODS:** JAYMART floorings and accessories are produced by highly sophisticated and modern manufacturing methods. However, due to differing production batches and or varying individual product manufacturing processes, colour and shading variations can occur and must be accepted.
13. **COLOUR SAMPLES:** The small hand feeler samples given or sent to enquirers are an indication of colour only . They are not necessarily representative of the actual product colour shade to be supplied
14. **PRODUCT CHANGES:** The policy of the Company is one of increasing improvement and development, so we reserve the right to add or delete from the range or to change products without notice
15. **TITLE TO GOODS:** We reserve the right to retain, if we should so decide, the title to goods supplied under these terms of sale until the purchaser has discharged all sums owing to us. Until such discharge, the purchaser shall hold the goods, whether or not sold to another party upon trust for ourselves and grant us the right, if we so wish, to enter the purchaser's or its agent's premises to recover any such goods.
16. **CANCELLATIONS.** We will consider, but not be bound to accept, any request for cancellation of an order, and acceptance shall be on such terms as may be agreed by us in writing.
17. **RETURNS:** We do not normally accept return of perfect goods if correctly supplied as ordered. We therefore strongly recommend that customers check quantity, colour and product requirements carefully before ordering. If goods are accepted for return for whatever reason, we reserve the right to levy an administration charge together with carriage costs incurred for original despatch. No requests for return will be considered more than 3 months after invoice date.
18. **COLLECTIONS:** Our warehouse is usually open for collection from Monday to Friday (9 a.m. to 12.30 p.m. and 2 p.m. to 5.30 p.m.) excluding holidays. We kindly request customers, however, to give us reasonable advance warning of intended collection of goods required. We regret that we cannot accept any claims whatsoever in such cases, if goods are unavailable at the time of collection. All promises of stock availability are given in good faith, but should not be regarded as guaranteed correct.
19. **SETTLEMENT:** Approved credit account customers should make their payments by the end of the month following the date of invoice. Cleared funds are required from non-credit account customers before goods can be released. Prepayment may be made by cheque, postal order, cash, bank transfer/CHAPS or most major credit/debit cards.
20. **VAT:** Is chargeable extra at current rate on prices listed.

PLEASE NOTE: While every effort is made to ensure accurate representation of colours, variations may occur due to limitations in the printing process. We always recommend, and are happy to supply free-of-charge, hand-held samples for colour reference.



FOR MATS THAT MATTER